

RESEARCH

Open Access



Stabilization of inter-area oscillations in two-area test system via centralized interval type-2 fuzzy-based dynamic brake control

Mohamed Fayez^{1*} , Mohamed Mandor², Mohamed El-Hadidy³ and Fahmy Bendary²

*Correspondence:
eng_mf69@yahoo.com
¹ Cairo Electricity Production
Company (CEPC), Cairo,
Egypt
Full list of author information
is available at the end of the
article

Abstract

Inter-area oscillations are, by far, the most detrimental oscillation category to the integrity of synchronously interconnected power systems. Inter-area oscillations are characterized by the inherent weak damping. The inherent poor damping associated with the inter-area oscillations leaves open wide probabilities for irrevocable widespread blackouts with the consequent eventual devastating outcomes measured in terms of the huge economic casualties and the possible human fatalities. The main purpose of this work is to mitigate inter-area power oscillations. This article explores the effectiveness of dual thyristor controlled braking resistor units with Interval Type-2 fuzzy-based centralized architecture for neutralizing the jeopardy of inter-area power oscillations in Kundur's two-area test system using MATLABTM/Simulink environment. The effectiveness of the proposed scheme is examined by considering four case studies with different degrees of severity. The simulation results show that the proposed scheme is simple yet effective in treating the inter-area oscillations appropriately under the considered case studies.

Keywords: Inter-area oscillations, Interval type-2 fuzzy controller, MATLABTM/Simulink, Thyristor controlled braking resistor

Introduction

Inter-area mode, simply inter-area, oscillations are associated with a combination of closely coupled coherent generators or generating stations in a power system swinging with respect to another combination of closely coupled coherent generators or generating stations in another power system [1]. Stabilization of inter-area oscillations has been a matter of overwhelming concern in the power industry community because of their dangerous ramifications on the power network [1]. Power system oscillations impose critical loading limits on a transmission interface beyond which the secure operation of a power network is jeopardized [1, 2]. Inter-area oscillations are believed to be the root cause behind many widespread blackout events [1, 2]. Moreover, poorly damped power system oscillations impose serious antagonistic effects on the generation establishments and the transmission facilities and severely retrograde the transmitted power quality which could impact the customers' loads fed directly from transmission network very badly [3]. Inter-area oscillations are characterized by their low frequencies and mostly

accompanied with inherent weak damping action [2]. The natural damping action for inter-area oscillations is considerably declined as a direct result to the weak interconnection between the two systems and the aggregate electric power transfer handled between the two power systems [4]. Inter-area oscillations cause the two power grids to experience periodic power swings with a frequency range of 0.05–0.8 Hz [4]. Inter-area oscillation damping characteristics is mightily specified by the electrical strength of the transmission interface, and the amount of electric power flowing through the transmission interface [5].

For determining the maximum tolerable power transfer limit through a transmission interface, there has been abiding commercial stress enjoined on the transmission system operators at some circumstances to utilize the full potential of certain strategical interconnecting tie-line because of the lack of future transmission expansion projects [4]. Furthermore, due to the pursuing transition of the electric power utilities to a platform, some interconnecting tie-lines become, all of a sudden, obligated to transmit bulky power transactions which could provoke the commencement of negatively damped inter-area power oscillations [6]. Also, the growing and enduring pace of interconnections between electrical power systems at a world-wide scale leads to the uprising of negatively damped inter-area oscillations which are considered precursor of widespread blackout events [4].

The main aim of this work is to stabilize the inter-area power oscillations which are highly encouraged by the well-recognized fact that many widespread total power outages with the consequential enormous economic casualties were due to negatively damped inter-area oscillations [7]. For instance, the unstable inter-area oscillations have been blamed for the 1996 Western Electricity Coordinating Council (WECC) blackout event [6]. This disastrous incident was held chargeable for the disconnection of 28,000 MW of electric load with the consequential devastating outcomes metastasizing all over the western side of the North American continent affecting nearly 7.5 million consumers [7].

Blackouts generally have many devastating outcomes in socioeconomic and political aspects [8]. With regards to the social aspects, prolonged blackouts completely paralyze the medical facilities with the consequent halt of the various life support systems and the possible damage of the refrigerated drugs and vaccines which could leave human life casualties [8]. Also, the communication infrastructure will not be functioning with the possible outbreak of chaos. With regard to the economic aspects, blackouts cause multibillion-dollar economic losses since the factories cease to produce their products, and the perishable foods in hypermarkets will be spoiled [8]. Moreover, the electricity utilities will pay indemnifications to the big consumers, overtime charges to the employees that are performing for the restoration procedures and the employees responsible for fixing the grid damages. With regards to the political aspects, blackout make the strategic security systems much more vulnerable to cyberattacks endangering the political safety of the countries [8]. Also, during the prolonged blackout events, the military bases and air defense bases spreading around the country will be not be operational causing the valuable military arsenal to be idle in case of the enemy attacks [8].

To reduce the possibilities of blackout accidents related to inter-area oscillations, the damping of the power system should be boosted [1, 2]. Among the participating

sources of the electric grid natural damping is the network loading burdens [2]. Thus, if the network loading level is momentarily increased, just for a little bit, to allow for the excess energy to be properly dissipated and hence the balance between the electrical and mechanical energies to be restored and maintained, adds supplementary positive damping to the network natural damping. One way to accomplish this task is the employment of dynamic resistor braking strategies [9]. The strategy of dynamic resistor braking in power grids is simply depending on the energization of an artificial load banks in case of the power grids is accelerating due to severe system faults and after the balance between the electrical and mechanical energies is restored or in case of the power grid is decelerating the control scheme de-energizes the artificial load bank [9]. The preferential selection of the artificial load banks is purely resistive load and the preferential interconnection to the grid is the shunt connection [9]. The vast majority of the real-life implementations of dynamic resistor braking strategies utilize the shunt-connected resistive elements while the implementation of series braking resistor is still being in the theoretical stage.

Among the several methods that have been developed to stabilize inter-area oscillations is the dynamic braking strategy [6]. The conceptual principle of the dynamic resistor braking devices installed in transmission network is simply to put in service an extra dummy electric load, for a moment, to consume the excess transient energy build up due to severe short circuit conditions and remove it from service elsewhere [7]. The literature is very rich with many research articles addressing the implementation of dynamic braking resistor interfaced to the grid via a 3-phase bi-directional, full wave, phase-controlled ac/ac converter, i.e. Thyristor Controlled Braking Resistor (TCBR), for enhancing the system transient stability, mitigating the steam turbine-generator multi-modal shaft torsional oscillations, and tempering the Sub-Synchronous Resonance (SSR) torque oscillations in series capacitor-compensated power systems by utilizing a local control signal synthesized from the generator rotor speed [10–13]. The per-phase model of TCBR is composed of two high-power thyristor valves in a back-to-back connection with linear resistor bank in series [12].

The stabilization scheme proposed herein incentivized by the conclusions obtained from [14]. In [14], authors presented a single TCBR device for damping inter-area oscillations in well-known Kundur's two-area benchmark utilizing the speed of equivalent one-machine infinite bus ($OMIB_{Speed}$) system as an energization control signal for the TCBR without deeming any artificial intelligence (AI)-based controller. Also, in [14], the authors introduced the response of $OMIB_{Speed}$ to elucidate the damping performance of the installed TCBR. This work explores a centralized Interval Type-2 fuzzy logic controller (IT2FLC) to symphonize the switching operation of dual TCBRs in a coordinated fashion for the purpose of stabilizing the inter-area power oscillations provoked in Two-area Kundur test system. Like [14], the implemented control signal for the proposed IT2FLC in this work is the $OMIB_{Speed}$, as a global control signal for both TCBR devices. The IT2FLC takes the responsibility for deciding the switching strategy for the dual TCBRs using MATLABTM/Simulink simulation platform. It is worthwhile to mention that no similar work could be found in the literature regarding the implementation of IT2FLC-based TCBRs for stabilizing the inter-area power oscillations. Unlike [14], this work will present the of inter-area

active and reactive power flow responses to elucidate the ability of the proposed stabilization scheme.

The remaining of this work is constructed as follows. Section “System model” briefly describes the system under investigation. Section “Fuzzy controller design” provides the introduction to the idea of implementing the IT2FLC to coordinate the dynamic braking interventions of the proposed double TCBRs. Section “Simulation results” depicts MATLAB™/Simulink time-domain simulation results in a comparative fashion accompanied with comments. Section “Conclusions” presents the key conclusions of this work. Finally, the references list utilized in this work is presented.

System model

In this work, the popular Two-area Kundur test system is considered to examine the stabilization performance of the proposed scheme. It is an interconnected power system with two-area and the one-line diagram of the test system is shown in Fig. 1 [7]. It is a suppositious interconnected power system with practical parameters, and it has been excessively employed for investigating power system oscillations [7]. This benchmark model was initially constructed by the combined participation of P. Kundur, G. J. Rogers, and M. Klein in 1991, and they presented a thorough investigation of the inter-area mode of oscillation in power system with highlighting the different aspects that directly influence it [15].

The base benchmark test system composed of two virtually identical areas (power pools) interconnected by three 230 kV transmission lines (220 km) which makes the transmission interface relatively weak particularly with bulk power interchanges [7]. Only two tie-lines are taken into consideration in this work creating an extra stressed version of this model. Each area has two perfectly similar synchronous generator of round-rotor type rated (20 kV/900 MVA/3600 rpm), and the only difference in the machines parameters is the inertia constant (H) which equals 6.5 s for each machine in area 1 (i.e., H_1 and H_2), and 6.175 s for each machine in area 2 (i.e., H_3 and H_4), respectively [7]. Each generator is supposed to be driven by steam turbine. For brevity, all the parameters and the dynamic data for the test system could be readily obtained from [7].

Three electro-mechanical modes of low frequency oscillation are stimulated in the test system, two local modes, and one inter-area mode [7]. The test system is supposed to have a significant load/generation mismatch within area (2) which makes area (1) to

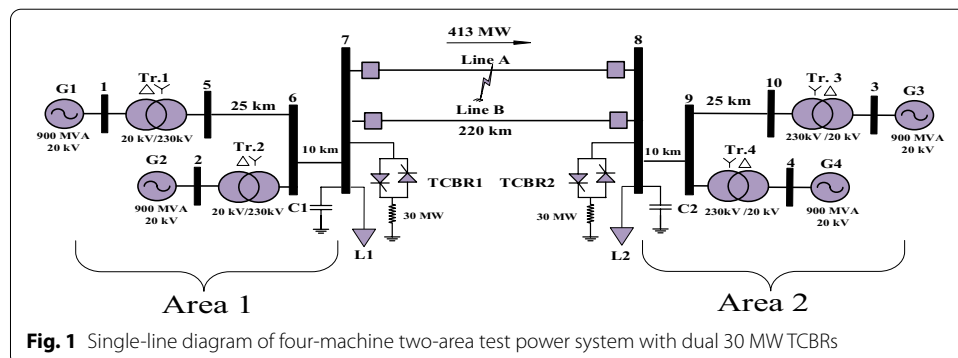

Fig. 1 Single-line diagram of four-machine two-area test power system with dual 30 MW TCBRs

supply the power needed by area (2). The distribution of generated powers and loads demands for a power flow of about 413 MW, as identical to the work found in [7], to be exported from area 1 to area 2, as it is obvious from the direction indicated by the arrow depicted in Fig. 1.

Each power area contains a 30 MW TCBR which are installed at both ends of the interconnecting transmission interface, i.e., at bus 7 and at bus 8, as shown in Fig. 1. Both TCBRs are controlled by a centralized IT2FLC to harmonize the interventions of the dual dynamic brake for the test system. Detail depictions of both TCBRs are presented in Fig. 2.

Many global control signals such as total kinetic energy deviation (TKED), the time derivative of the TKED, and the speed of equivalent one-machine infinite bus ($OMIB_{Speed}$) are efficiently employed as an insertion control signal for the dynamic braking resistor devices [14, 16]. In this paper, the $OMIB_{Speed}$ is utilized as an input control signal to the centralized IT2FLC.

$$\omega_{Area1} = \frac{1}{H_1 + H_2} [\omega_1 H_1 + \omega_2 H_2] \tag{1}$$

$$\omega_{Area2} = \frac{1}{H_3 + H_4} [\omega_3 H_3 + \omega_4 H_4] \tag{2}$$

$$OMIB_{Speed} = \omega_{Area1} - \omega_{Area2} \tag{3}$$

Then, the power that should be dissipated by each TCBR relies on the $OMIB_{Speed}$. Therefore, if ω_{Area1} is larger than ω_{Area2} then the $OMIB_{Speed}$ is positive and area 1 has more kinetic energy than area 2 which necessitate the energization of $TCBR_1$ to maintain the energy balance between the two areas. Quite the contrary, if ω_{Area2} is larger than ω_{Area1} then the $OMIB_{Speed}$ is negative and area 2 has more kinetic energy than area 1 which necessitate the energization of $TCBR_2$ to maintain the energy balance between the two areas. And if ω_{Area1} is equal ω_{Area2} then the $OMIB_{Speed}$ is zero and there is no

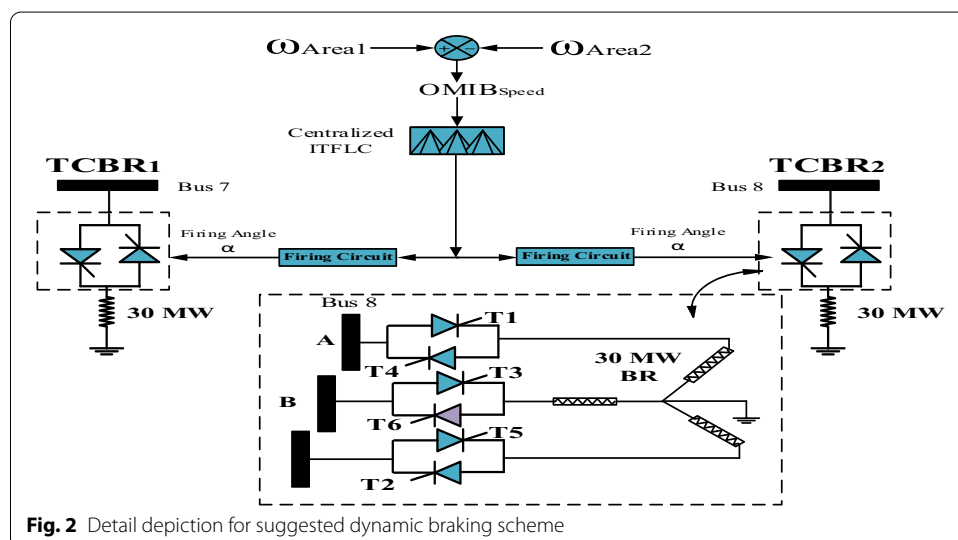

need for the TCBR to be energized. The proposed scheme in this work relied on the hypothetical post-existence of the communication infrastructure needed for the acquisition of the $OMIB_{Speed}$ in the test system to the location of the centralized IT2FLC.

The test power system simulation is conducted via SimPower[®] of MATLAB[™]/Simulink which is possible to find the complete system as a demo [17]. Three nonlinear time-domain simulation case studies are conducted to highlight the capability of Interval Type-2 fuzzy logic controlled TCBRs to sufficiently stabilize inter-area power oscillations through ON–OFF (bang–bang) Type-2 fuzzy-based control.

Fuzzy controller design

Type-2 fuzzy logic control is based on type-2 fuzzy set (T2FS) where there are uncertainties about the membership functions [18]. Type-2 fuzzy logic is the state-of-the-art in the fuzzy logic arena in [18]. Type-2 fuzzy logic is conceptually based on type-2 fuzzy set theory which was originally introduced to the academic peer community by Lotfi Zadeh back in mid-seventies [18]. In 1975, Zadeh extended his original work and came up with the concept of T2FS [18]. In T2FS, the membership function is fuzzy in nature, i.e., each element has degree of membership described by a type-1 fuzzy membership function and has belonging degrees lying on the range from 1 to 0 [18]. T2FS introduces extra degrees of freedom during the design procedures of fuzzy systems which help the designer to deal with the additional uncertainties originated from the various types of noises and their adverse impacts on data communications and the ever-changing environments in a more resilient manner [18]. The membership function types of T2FS are like their conventional counterpart [19]. For instance, Gaussian T2FS is a fuzzy set having the grade of membership for every involving element is a gaussian type-1 fuzzy set [19]. Gaussian T2FS could be with uncertain standard deviation (σ) or uncertain mean (M) [19].

Very recently, Type-2 fuzzy logic has gained so much reputation inside the peer society in engineering fields due to its amazing ability to accommodate greater levels of uncertainty involved in the system's parameters [19]. Type-2 fuzzy logic is now broadly received a considerably more attention with very promising potentials in fields such as modeling, pattern recognition, and control and classification [19]. Type-2 fuzzy logic becomes preferential choice for many researchers when there are control situations characterized by the difficulty of determining the appropriate membership function for a fuzzy set [19]. Controllers based on Type-2 fuzzy logic theory have been utilized for handling many power system problems as a superior alternative for conventional fuzzy logic controllers [20–26]. Many works of literature highlights approaches based on the Type-2 fuzzy logic theory to design intelligent power system stabilizers for damping slower type of oscillation [20, 23]. Type-2 fuzzy logic is implemented to control a TCSC device to provide supplemental damping to the power system oscillations [24, 25]. It is used to design an intelligent control strategy for integrating the doubly fed induction generator (DFIG)-based wind turbines to the distribution network [26].

The structural block diagram of a generic Type-2 fuzzy logic controller (T2FLC) is pictured in Fig. 3 [18, 19]. The main components of T2FLC are a Fuzzifier, a Rule-Base, an Inference Engine, a Type-Reducer, and a Defuzzifier.

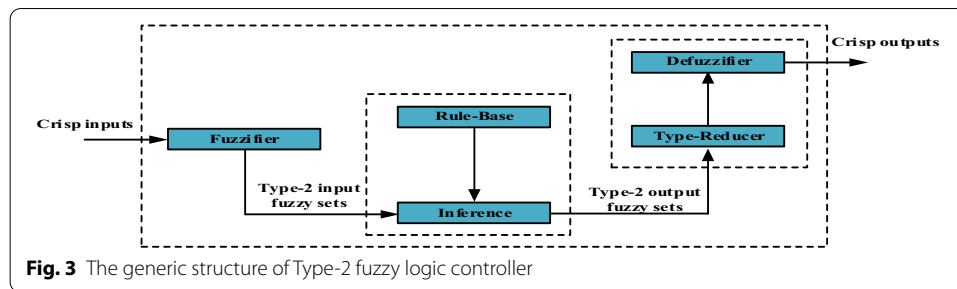

The output processing block is the only difference between the structure of traditional fuzzy and the T2FLC and it has two processing stages, namely, defuzzification and type-2 reduction [18, 19]. In the type-reduction stage, the output T2FS is reduced to type-1 fuzzy set T1FS which is also called as the type-reduced set [18, 19]. In the defuzzification stage, the type-reduced set is defuzzified to obtain the final crisp (type-0) output [18, 19]. In T2FLCs, not all the consequents and antecedents of fuzzy rules are necessarily of type-2. A fuzzy controller is categorized under type-2 classification if only one T2FS is involved [19]. There many techniques for type-reduction procedures, such as center of sums, center of sets, centroid, modified height, Karnik–Mendel (KM) algorithm, enhanced KM (EKM) algorithm, iterative algorithm with stop condition (IASC), enhanced IASC (EIASC), enhanced opposite direction searching (EODS) algorithm, Wu-Mendel (WM) uncertainty bound method, Nie-Tan (NT) method, and Begian-Melek-Mendel (BMM) method [18, 19, 27].

Many academic researchers have been dedicating much of their focus on a less sophisticated version of a generic T2FLC known as interval type-2 fuzzy logic controller (IT2FLC) [19]. IT2FLC is based on Interval Type-2 fuzzy set (IT2FS) where the membership degree for each input is itself an interval-valued fuzzy set, unlike the conventional counterpart, i.e., Type-1, fuzzy set where the membership degree is a crisp number lying between zero and one [19]. So, IT2FLC will be utilized in this project. The proposed controller is designed with the aid of the IT2FLC toolbox illustrated in [28]. The fuzzy inference type utilized in this project is of Takagi–Sugeno-Kang (TSK) type in which the fuzzy rule consequent is constant, i.e., zero-order type-2 Sugeno model, and that the necessity for a type reduction and defuzzification is diminished will further reduce much more of the involved computational burden [18].

Interval Type-2 sigmoid and Gaussian membership functions are selected to represent the input control variable of the proposed Interval IT2FLC (i.e., $OMIB_{Speed}$). The membership functions for the of input are shown in Fig. 4 in which three linguistic variables, namely, NB (Negative Big), ZE (Zero), and PB (Positive Big), are realizing the Type-2 fuzziness of the controller input. The parameters of each membership function are fixed throughout the simulation study for all the considered case studies and determined by Hit and Trial approach in accordance with the $OMIB_{Speed}$ ceiling limits. The output is constant having either -1 , 0 , or 1 values (-1 for NB, 0 for both ZE, 1 for PB). where -1 indicates that $TCBR_2$ should be energized, 1 indicates that $TCBR_1$ should be energized, and 0 indicates that both $TCBRs$ should be de-energized.

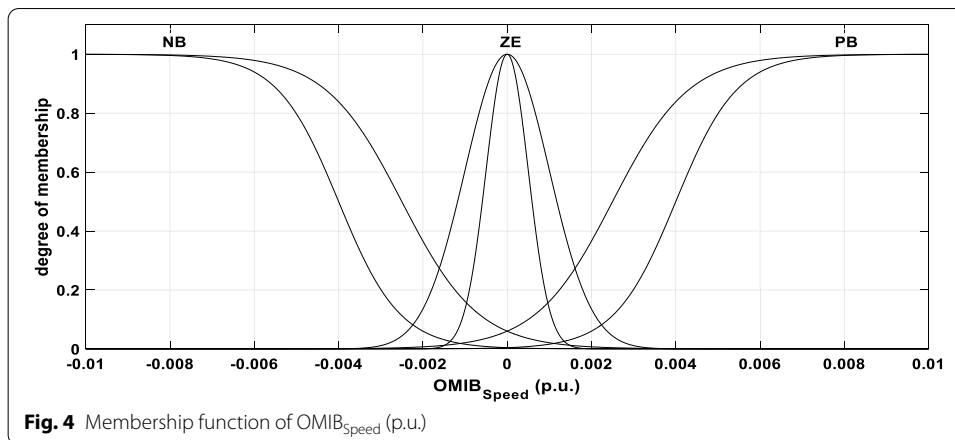

The proposed Interval Type-2 fuzzy-based dynamic brake control scheme is simple because there are only three involved control rules where the TCBR₁ is energized if the $OMIB_{Speed}$ exceeds a certain positive value and the TCBR₂ is energized if the $OMIB_{Speed}$ exceeds a certain negative value and both TCBRs are de-energized for steady state conditions. There are three premise membership functions and single input depicted in Fig. 4 which results in three type-2 fuzzy control rules. The fuzzy rules harnessed in the rule-base of the proposed controller are as follows: If $OMIB_{Speed}$ is NB THEN the output is -1 , IF $OMIB_{Speed}$ is ZE then the output is 0, and If $OMIB_{Speed}$ is PB then the output is 1. The output signal of Interval Type-2 FLC is then sent to the thyristors firing circuitry which generates the triggering signals.

Simulation results

To further present a performance assessment of the proposed scheme, time-domain approach based on a nonlinear system model via Matlab/Simulink platform are carried out in this section. The test system under consideration is modeled in MATLAB software via Simulink toolbox. All the test system components are chosen from the MATLAB/Simulink library. All the bulk load banks included within the test system grid are modeled as a constant PQ load. The transmission system model data are borrowed from [7]. Four case studies in different degrees of severity are considered. All the following case studies are performed considering a power flow condition in which active power of 413 MW is transported from area 1 to area 2.

Case Study (1)-small voltage step change

Under the considered stressed operating conditions, the benchmark system is provoked to experience the inter-area oscillations by having a mild step increase of 0.05 p.u. in the reference voltage set point of generator number 1 from 0.5 to 0.7 s of the simulation time of 10 s. Figure 5 depicts the corresponding inter-area active power and reactive power flow responses as measured at the beginning of the transmission interface (i.e., at bus 7) with and without the IT2FLC-based dynamic braking interventions. Additionally, the relative synchronous machine speed responses are introduced in the outline of Fig. 6 to manifest the oscillation behavior of the inter-area mode of oscillation.

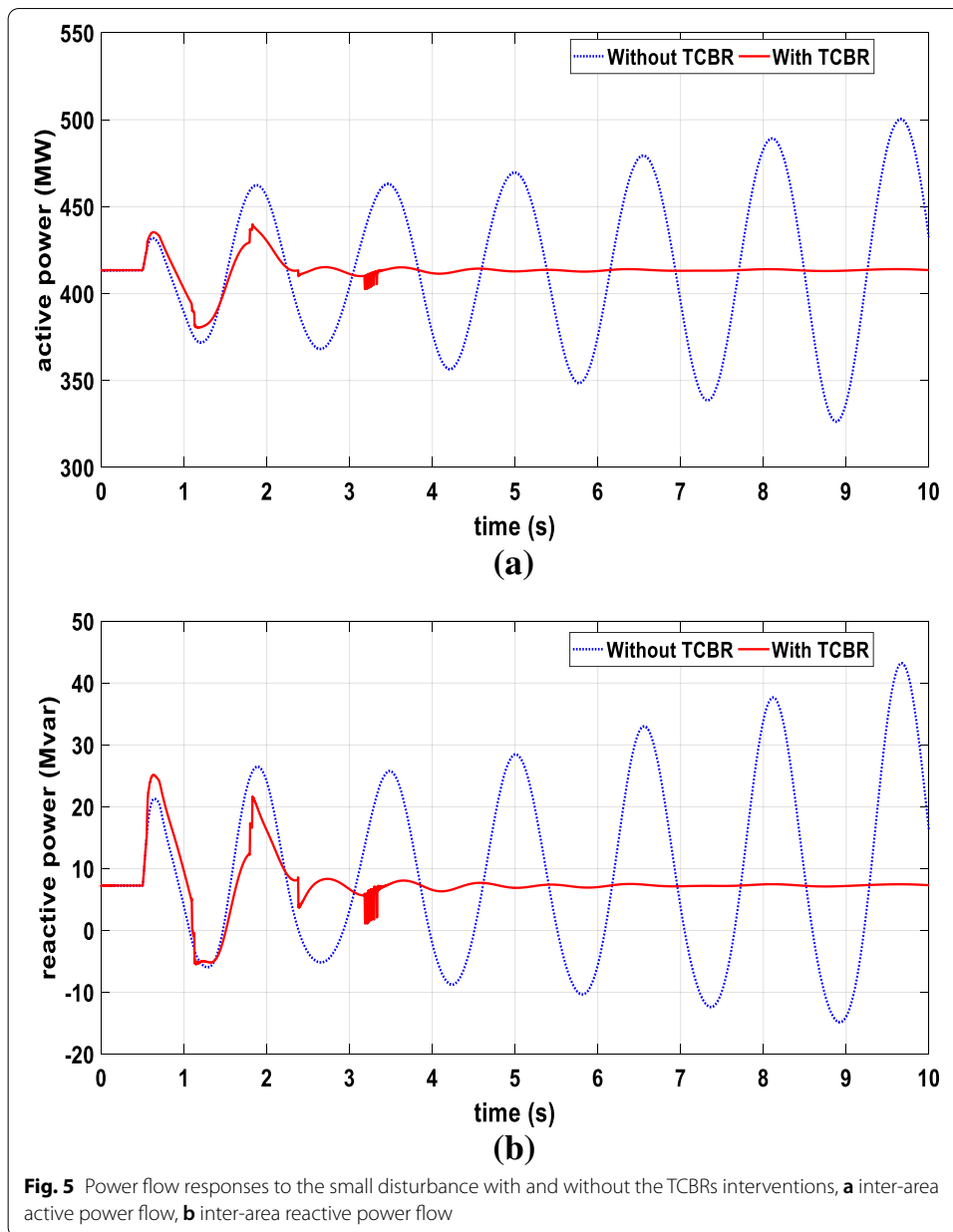

As it is clearly noticed from the above simulation results, without the suggested stabilization scheme, the amplitudes of the power and relative speed oscillations are periodically increasing which will inevitably end up with irrevocable loss of synchronism between the machines in area 1 and the machines in area 2. When the proposed scheme is applied, the oscillatory behavior of the system is stabilized after nearly 2 s from the perturbation initiation. The TCBR functioning is elucidated by analyzing the responses of the TCBR dissipated power with the control signal. Thus, the responses of the $OMIB_{Speed}$ and the three-phase dissipated power in each TCBR with and without the proposed scheme are depicted in Fig. 7.

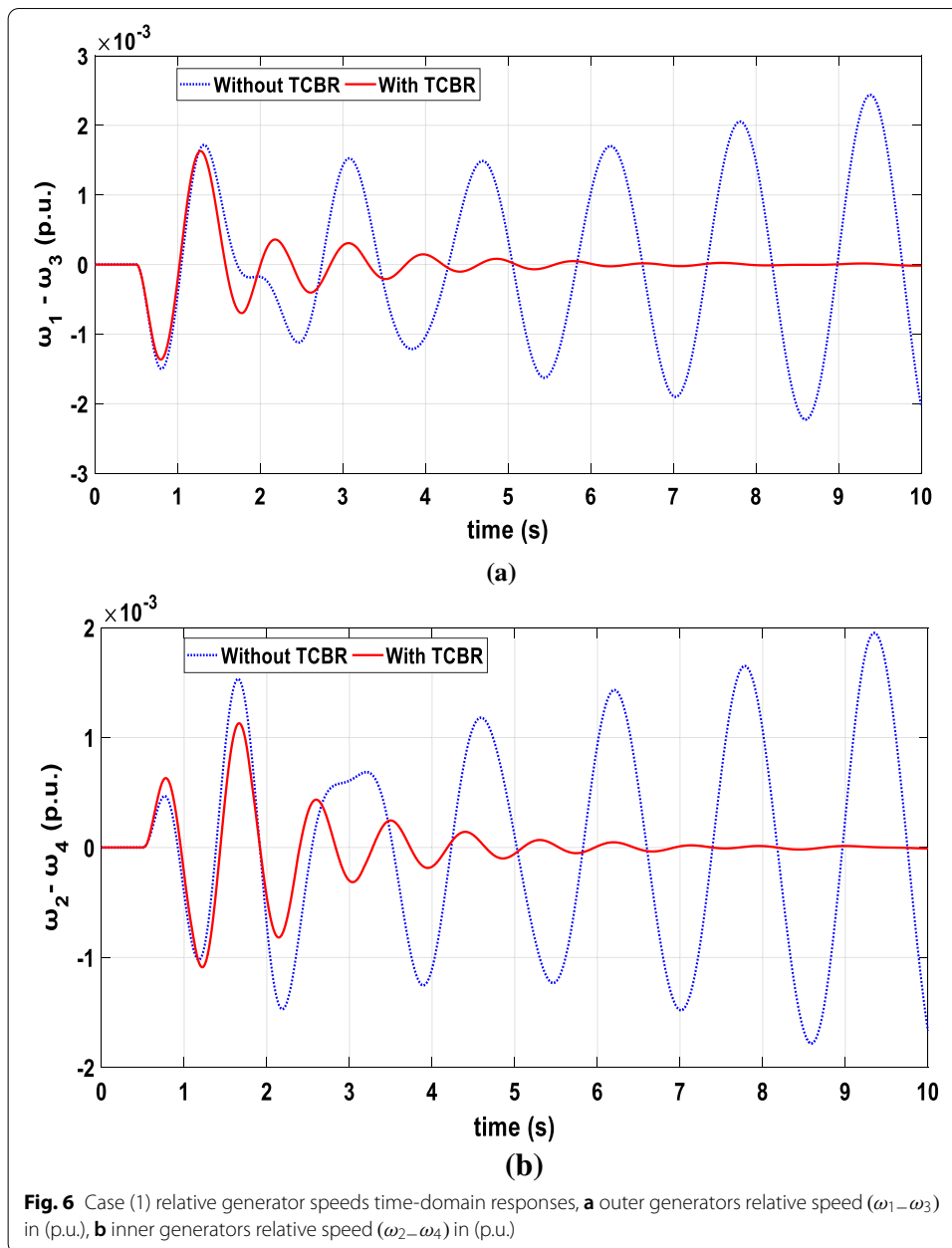

Referring to the family of curves depicted in Fig. 7, it is observed that the power dissipation become zero after 3.34 s for TCBR₁ and after 2.3 s for TCBR₂ with no further energization attempts until the end of the simulation time. This observation implies that the kinetic energy balance between both areas of the test system become virtually zero after 3.3 s of the simulation time due the employment of the proposed scheme.

Case Study (2)-200 MW step-load increase

The test system is stimulated to experience the inter-area oscillations by having a 200 MW step-load increase in area 2 at 0.5 s of the simulation time of 10 s. Figure 8 depicts the corresponding inter-area active power and reactive power flow responses

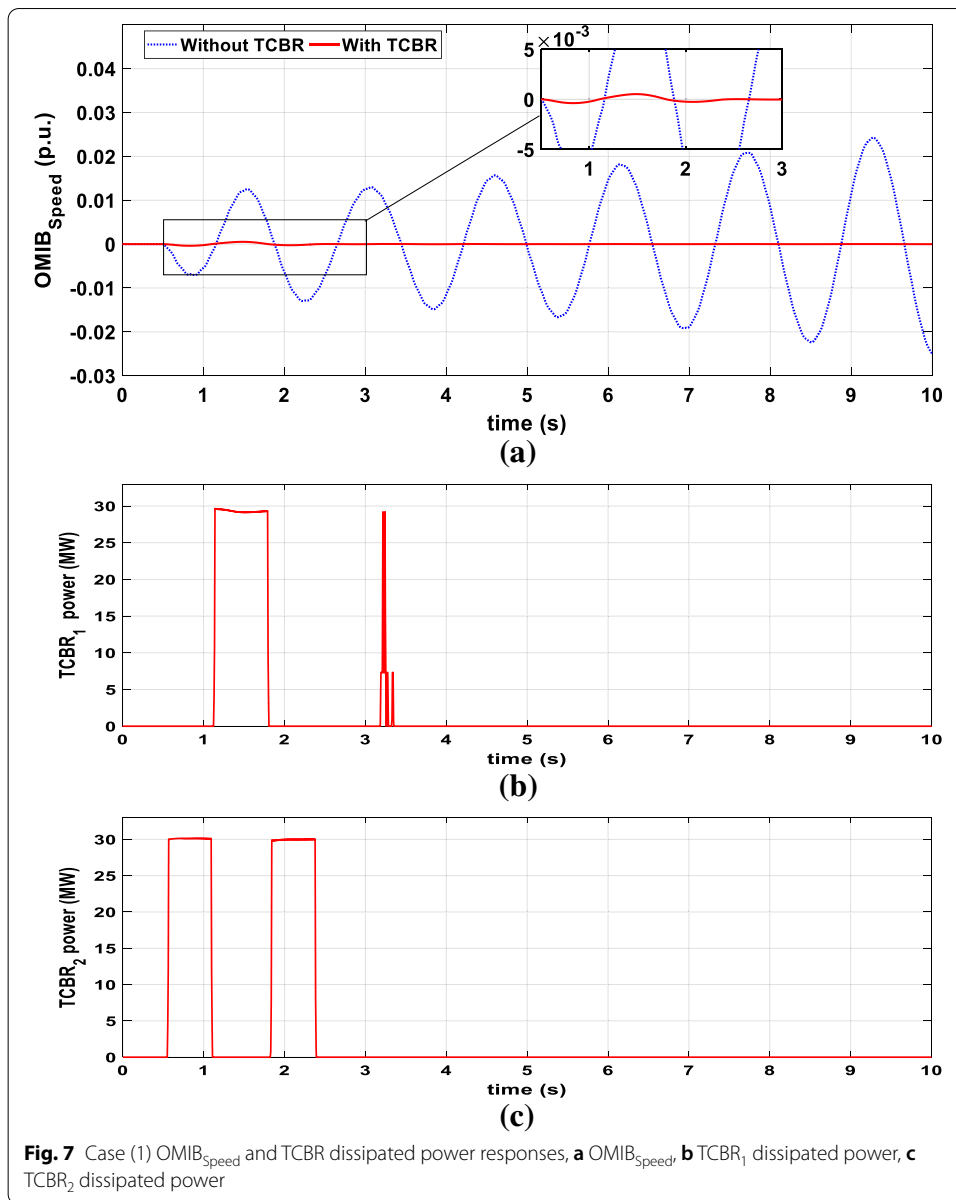

as captured at bus 7 with and without the Interval Type-2 fuzzy-based dynamic braking interventions. Also, the relative synchronous machine speed responses are introduced in the outline of Fig. 9.

Based on the earlier simulations results, in the uncontrolled plot (i.e., base-case plot), the amplitudes of the transmitted power swings and responses of the relative speeds are repeatedly growing as the simulation time progresses indicating the instability feature of the responses. The protective relaying schemes shall respond to these unstable oscillations by taking tripping actions to the various system elements and then inevitably, whole grid will be fated to separate. It is seeable from the prior results, that the employment of TCBR significantly alleviate the speed and power oscillations. It also seems that the OMIB_{speed}, RKED, and the inner generators relative

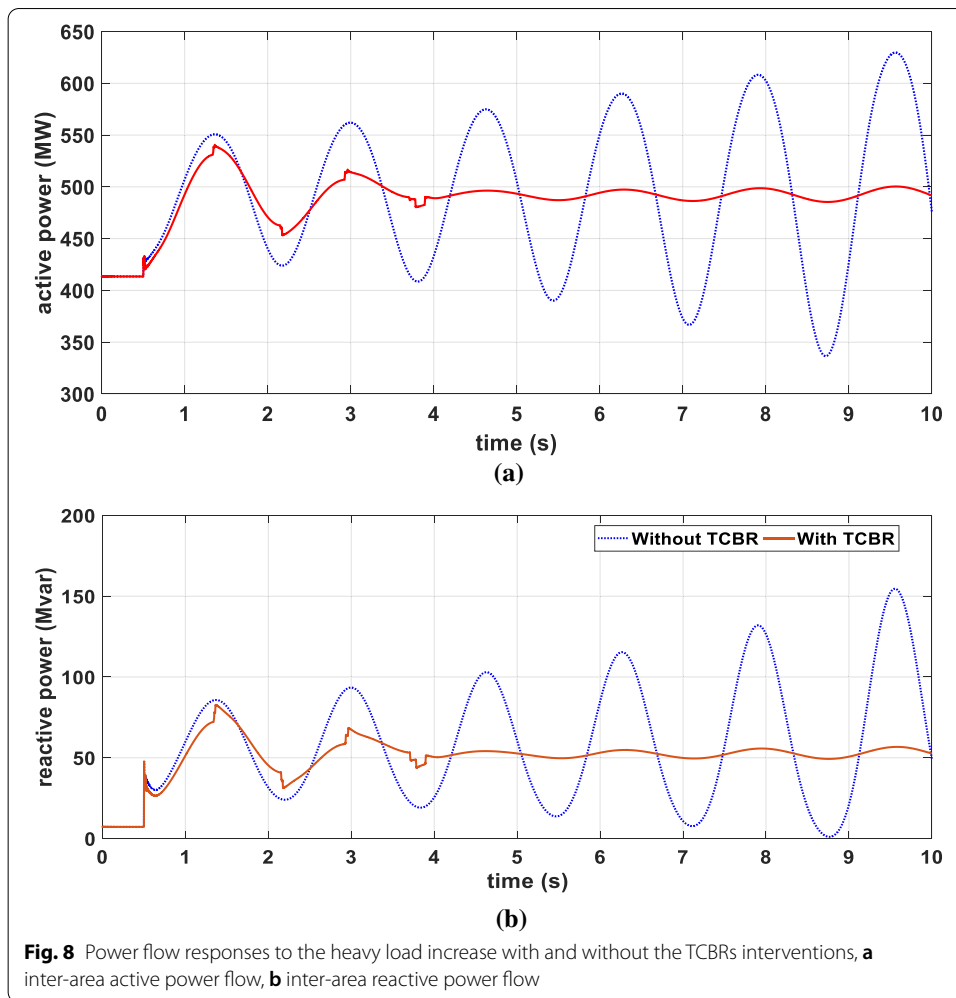

Fig. 8 Power flow responses to the heavy load increase with and without the TCBRs interventions, **a** inter-area active power flow, **b** inter-area reactive power flow

speed signals are effective in alleviating the developed oscillations. The TCBR alleviates the speed and power oscillations by absorbing the extra real power during the accelerating conditions. To elaborately elucidate the brake functioning, the responses of the TCBR real power dissipations in addition to the energization signal are exhibited in Fig. 10.

Referring to the family of curves depicted in Fig. 10, it is observed that the power dissipation become zero after 3.899 s for TCBR₁ and after 3.71 s for TCBR₂ with no further energization attempts until the end of the simulation time. This observation implies that the kinetic energy balance between both areas of the test system become virtually zero after 3.3 s of the simulation time due the employment of the proposed scheme.

Case Study (3)-line switching

In this case, the proposed stabilization scheme is examined to stabilize the inter-area power and relative speed oscillations encountered in the test grid to a mild disturbance. Switching of transmission line is one of the most frequently encountered and totally unavoidable events in the power grid's daily operation. Switching of transmission line is a more frequent on a permanent basis than as an emergency condition e.g., to permit

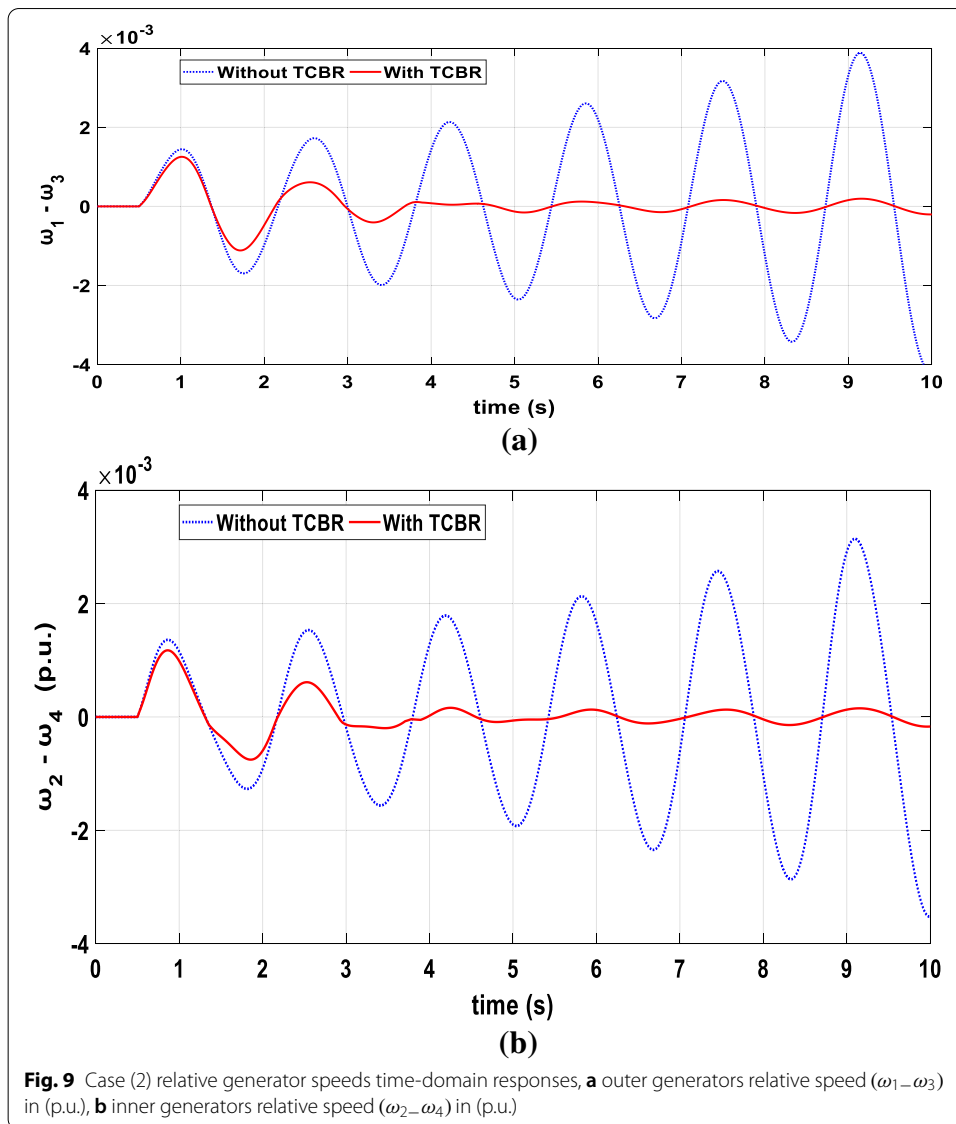

for the regular maintenance of a transmission line. Referring to Fig. 1, the interconnecting tie-line (A) is switched off at $t = 0.5$ s from the simulation time. Plots for the real and reactive powers exported from area 1 to area 2 (as recorded on bus 7) without and with the fuzzy-based resistor braking interventions are introduced in Fig. 11.

It is very obvious from the aforementioned results that the system loses synchronism after about 2.5 s of the simulation time from the instant of switching the line without the employment of the propositioned scheme. With the employment of the propositioned scheme, the test system maintains the synchronism state in a good manner. The $OMIB_{Speed}$ and TCBR dissipated power responses with and without the proposed scheme are portrayed in the family of curves shown in Fig. 12.

As it is clearly noticed from the responses of the $OMIB_{Speed}$ depicted in Fig. 12, the system loses its synchronism without the employment of the proposed stabilization scheme after less than 3 s of the simulation time. With the employment of the proposed

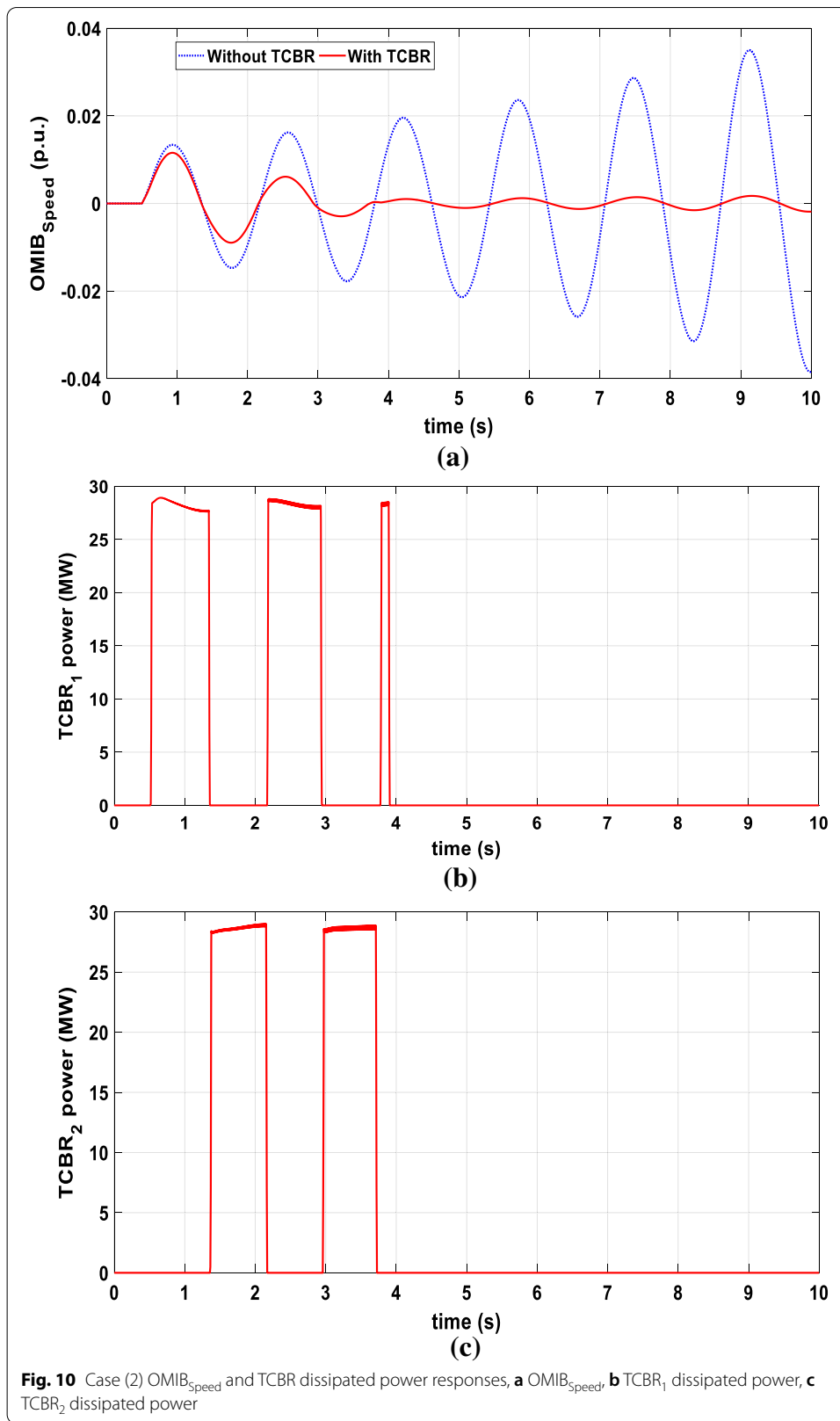

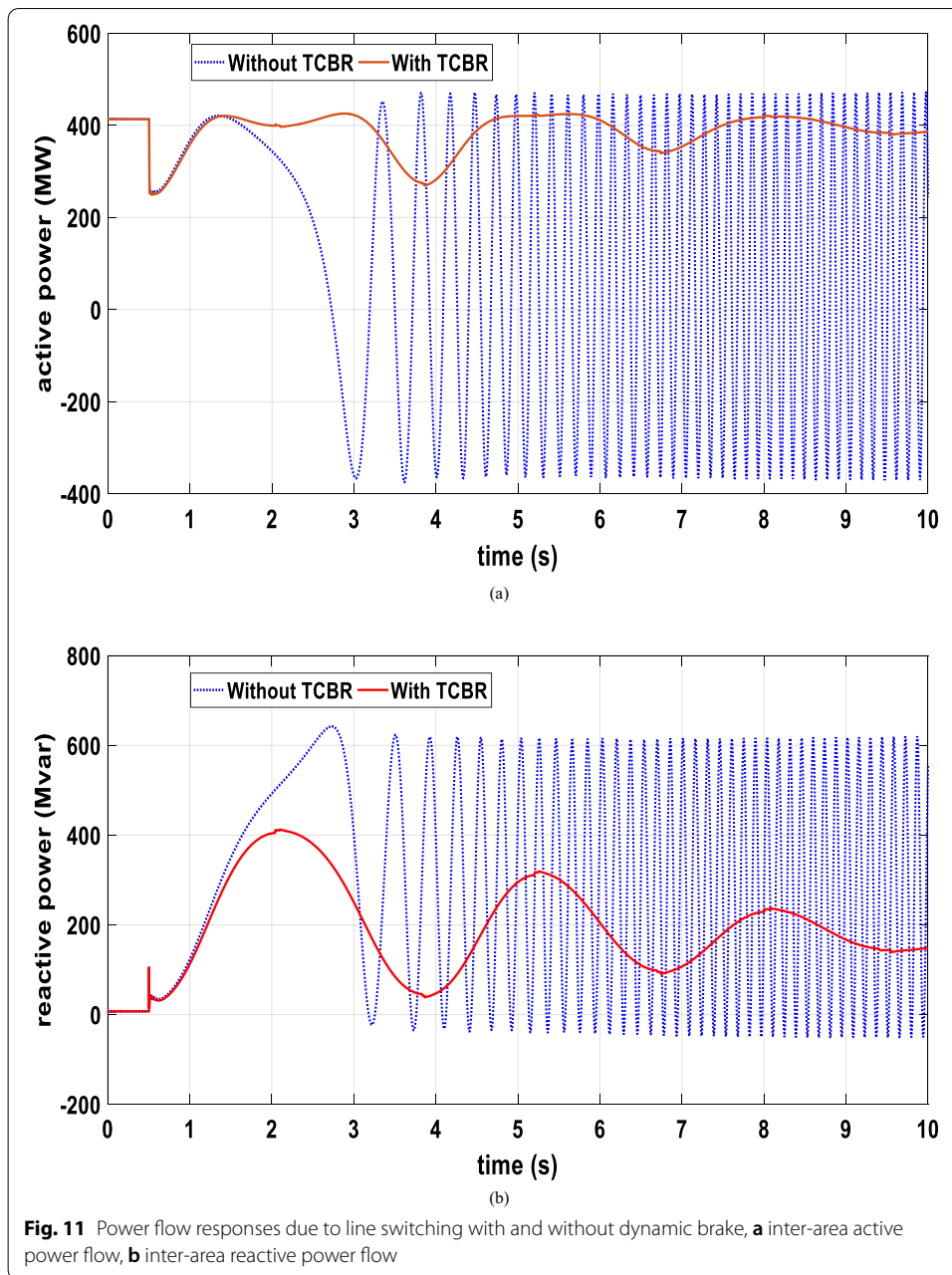

scheme, the response of the $OMIB_{Speed}$ of the system will experience a good supplemental damping.

Case study (4)-three-phase disturbance

In this case, the responses of inter-area active and reactive power are analyzed when the test system is subjected to a three-phase bolted fault condition at the middle of tie-line (A) at time $t = 0.5$ s. The disturbance is cleared in 3 cycles (0.05 s) from the its inception by the circuit breakers action. The comparative simulation results plotted in Fig. 13 depicts the power flow responses through the interconnecting transmission

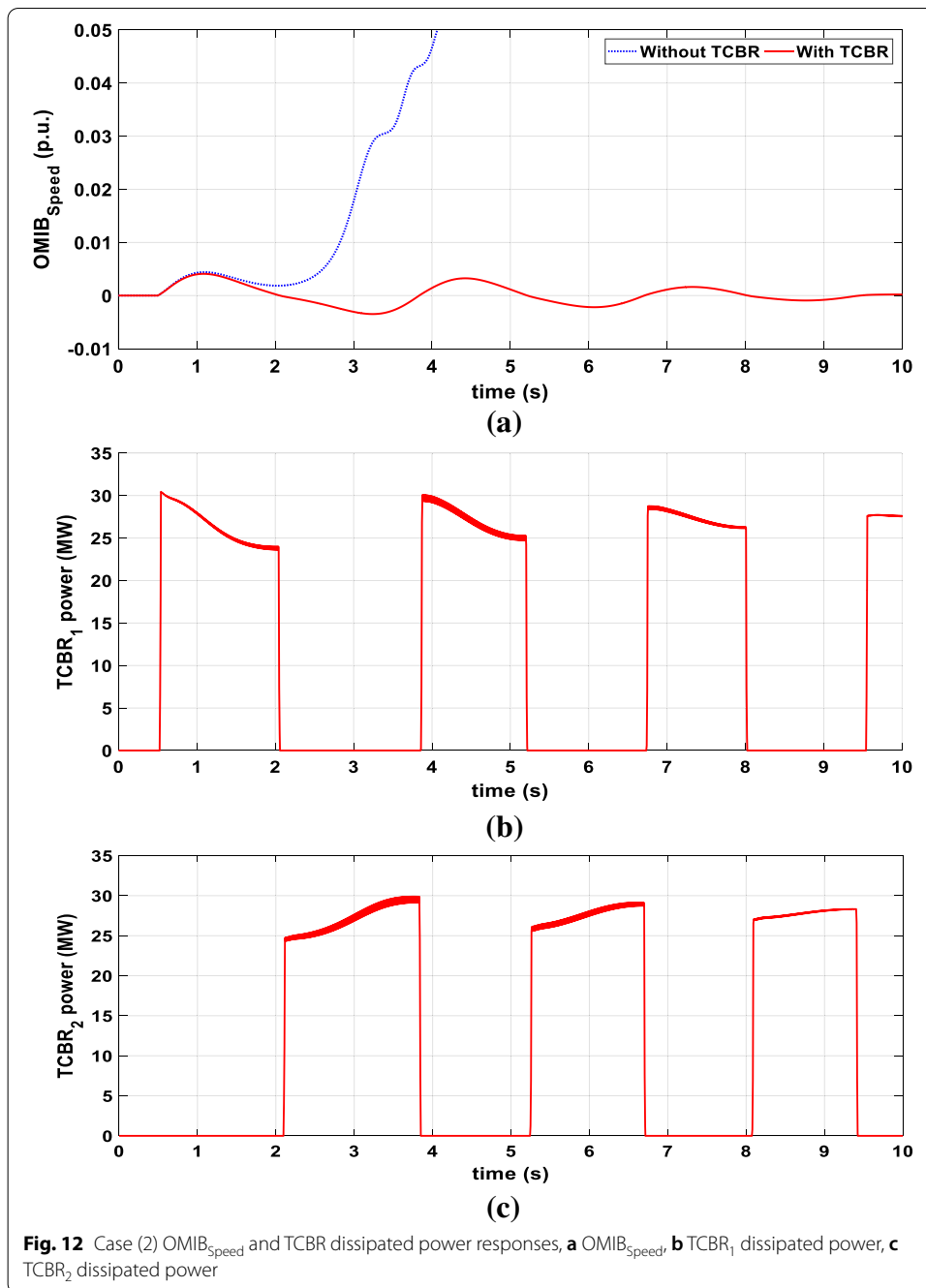

corridor of the test system of the system due to this severe disturbance with and without the proposed scheme.

It is very obvious from the aforementioned results that the system loses synchronism after about 3 s of the simulation time without the employment of the proposed scheme. With the employment of the proposed scheme, the system maintains the state of synchronism in an appropriate manner. Also, the system is sufficiently consolidated to survive this severe disturbance due to the employment of the proposed scheme.

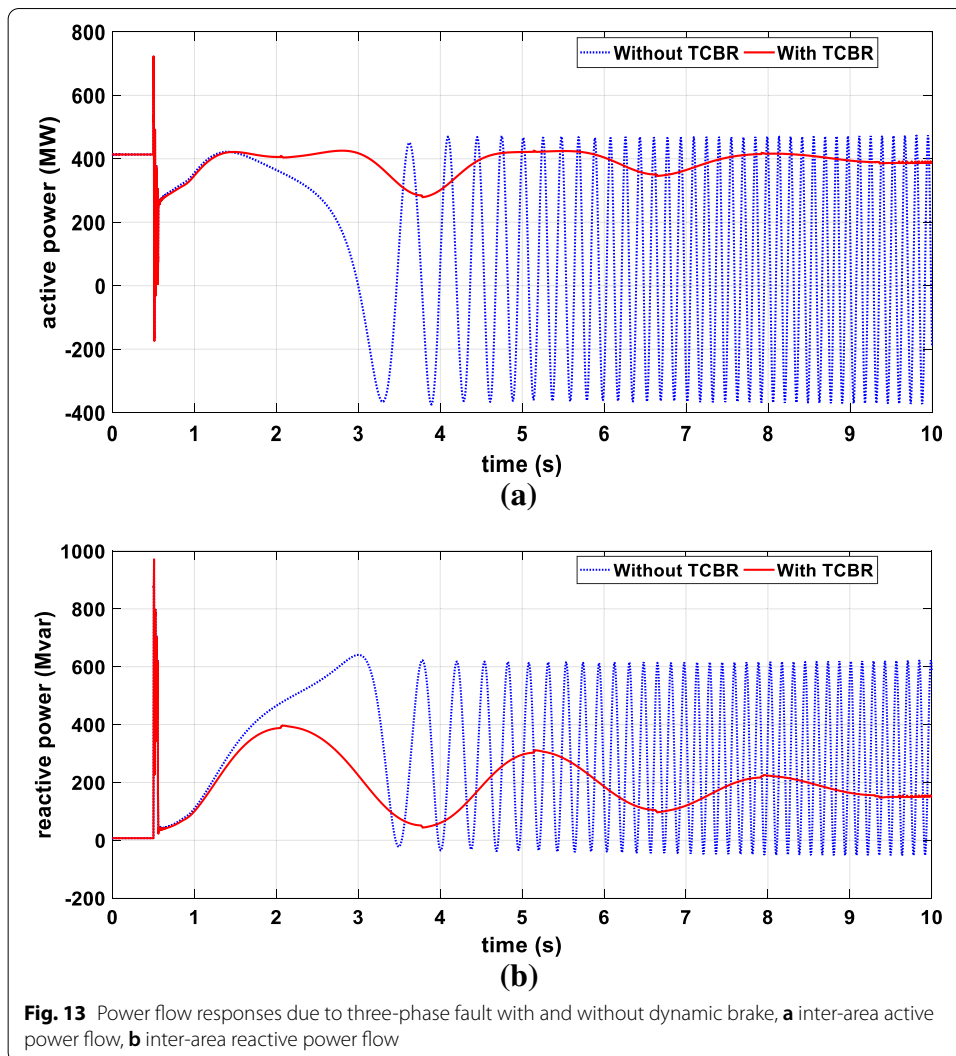

Fig. 13 Power flow responses due to three-phase fault with and without dynamic brake, **a** inter-area active power flow, **b** inter-area reactive power flow

Conclusions

In this article, a type-2 fuzzy-based resistor braking scheme is proposed to stabilize the inter-area oscillatory behavior manifested as a result of the various network disturbances. The propositioned scheme is tested on Kundur 4-machine 11-bus test systems. The key conclusion of this article is that the employment of dynamic resistor braking is providing an excellent supplemental damping to negatively damped inter-area oscillatory behavior manifested under stressed operating conditions. Also, the proposed type-2 fuzzy switching scheme is distinguished by its simpleness because only three rules are involved in the decision-making procedures which reduces the escalated computational burdens involved in real-life applications. In summary, the aforementioned time-domain simulation results presented within this article present an excellent impression on the capability of the proposed scheme, as a relatively cheap stabilization scheme, with regard to the negatively damped inter-area relative speed and power oscillations. Therefore, the implementation of the suggested scheme will make power networks much less vulnerable to the issues of unstable inter-area power and speed oscillations. Furthermore, the

employment of the proposed scheme should make the interconnected power systems less vulnerable to cascading element outages which are considered as the onset of the irrevocable widespread blackouts.

Abbreviations

AI: artificial intelligence; BMM: Begian–Melek–Mendel; DFIG: Doubly fed induction generator; EHM: enhanced Karnik–Mendel; EODS: enhanced opposite direction searching algorithm; H: inertia constant; Hz: hertz; IASC: iterative algorithm with stop condition; IT2FLC: interval type-2 fuzzy logic controller; IT2FS: interval type-2 fuzzy set; KM: Karnik–Mendel; NB: Negative Big; PB: Positive Big; OMIB_{speed}: speed of equivalent one-machine infinite; p.u.: per-unit; SSR: sub-synchronous resonance; T1FS: type-1 fuzzy set; T2FS: type-2 fuzzy set; TKED: total kinetic energy deviation; TSK: Takagi–Sugeno–Kang; TCBR: thyristor controlled braking resistor; WECC: Western Electricity Coordinating Council; ZE: zero.

Authors' contribution

The authors (MF, MM, ME and FB) presented a Centralized Interval Type-2 Fuzzy logic controller to regularize the braking interventions of dual thyristor controlled braking resistor units to help stabilizing the unstable inter-area power oscillations in Kundur's two-area test system using MATLAB[™]/Simulink environment utilizing the speed of equivalent one-machine infinite bus (OMIB_{speed}) system as an energization control signal. The individual contribution of each author could be listed as follows. MF did perform the simulation studies and write the manuscript. MM did help in designing the simulation environment. ME did help in interpretation of data. FB did help in writing the manuscript. All authors have read and approved the manuscript.

Funding

The authors are not getting any fund from any organization.

Competing interests

The authors declare that they have no competing interests.

Availability of data and material

All the data associated with the considered test system are available in a lot of research papers. The power system simulation is implemented in SimPower[®] of MATLAB[™]/Simulink which is possible to find the complete system as a demo. I. Kamwa, "Comparison of three Power System Stabilizer (PSS) using Kundur's Four-Machine Two-Area Test System", MATLAB[™] Demo.

Author details

¹ Cairo Electricity Production Company (CEPC), Cairo, Egypt. ² Electrical Engineering Department, Faculty of Engineering Shoubra, Benha University, Cairo, Egypt. ³ Egyptian Electricity Holding Company (EEHC), Cairo, Egypt.

Received: 2 September 2019 Accepted: 15 December 2020

Published online: 06 January 2021

References

1. Cui Y, Wu L, Yu W, Liu Y, Yao W, Zhou D, Liu Y (2017) Inter-area oscillation statistical analysis of the U.S. Eastern inter-connection. *J Eng* 11:595–605. <https://doi.org/10.1049/joe.2017.0243>
2. Wadduwage DP, Annakkage UD, Narendra K (2015) Identification of dominant low-frequency modes in ring-down oscillations using multiple Prony models. *IET Generat Transm Distribut* 9(15):2206–2214. <https://doi.org/10.1049/iet-gtd.2014.0947>
3. You S, Kou G, Liu Y, Zhang X, Cui Y, Till MJ, Yao W, Liu Y (2017) Impact of high PV penetration on the inter-area oscillations in the U.S. Eastern interconnection. *IEEE Access* 5:4361–4369. <https://doi.org/10.1109/ACCESS.2017.2682260>
4. Grigsby LL (2012) Power system stability and control. Taylor & Francis, Boca Roca
5. Lami FKA (2012) A new improved method to damp inter-area oscillations in power systems with SSR stabilization and zone protection compensation. Ph.D dissertation, Leicester University. <https://ira.le.ac.uk/bitstream/2381/27812/1/2013Lamifkaphd.pdf>
6. Neely JC, Byrne RH, Elliott RT, Silva-Monroy CA, Schoenwald DA, Trudnowski DJ, Donnelly MK (2013) Damping of inter-area oscillations using energy storage. In: Power & Energy Society general meeting. IEEE, pp 1–5. <https://doi.org/10.1109/pesmg.2013.6672775>
7. Hadjikypris M (2015) Supervisory control scheme for FACTS and HVDC based damping of inter-area power oscillations in hybrid AC-DC power systems. Ph.D dissertation, Manchester University. [https://www.research.manchester.ac.uk/portal/en/theses/supervisory-control-scheme-for-facts-and-hvdc-based-damping-of-interarea-power-oscillations-in-hybrid-acdc-power-systems\(cc03b44a-97f9-44ec-839f-5dcbcf2801f1\).html](https://www.research.manchester.ac.uk/portal/en/theses/supervisory-control-scheme-for-facts-and-hvdc-based-damping-of-interarea-power-oscillations-in-hybrid-acdc-power-systems(cc03b44a-97f9-44ec-839f-5dcbcf2801f1).html)
8. Alhelou HH, Golshan MEH, Njenda TC, Siano P (2019) A survey on power system blackout and cascading events: research motivations and challenges. *Energies* 12(682):1–28. <https://doi.org/10.3390/en12040682>
9. Kundur P (1994) Power system stability and control. McGraw-Hill, New York
10. Ahmed MF, Ebrahim MA, EL-Hadidy MA, Mansour WM (2018) Torsional oscillations mitigation for interconnected power system via novel fuzzy control based braking resistor model. Presented at 47th International Council on Large Electric Systems (CIGRE). pp 1–9. https://e-cigre.org/publication/SESSION2018_A1-208
11. Ahmed MF, Ebrahim MA, EL-Hadidy MA, Mansour WM (2016) Torsional oscillations mitigation via novel fuzzy control based braking resistor model. *Int Electrical Eng J (IEEJ)* 7(3):2173–2181

12. Saluja R, Ali MH (2013) Novel braking resistor models for transient stability enhancement in power grid system. In: IEEE PES innovative smart grid technologies (ISGT) conference. IEEE, pp 1-5. <https://doi.org/10.1109/ISGT.2013.6497838>
13. Saluja R, Ghosh S, Ali M H (2013) Transient stability enhancement of multi-machine power system by novel braking resistor models. In: IEEE Southeastcon conference, IEEE, pp 1-6. <https://doi.org/10.1109/SECON.2013.6567462>
14. Huseinbasic E, Kuzle I, Tomisa T (2009) Inter-area oscillations damping using dynamic braking and phasor measurements. In: 2009 IEEE/PES power systems conference and exposition. IEEE, pp 1-6. <https://doi.org/10.1109/PSCE.2009.4840068>
15. Fayez M, Mandor M, El-Hadidy M, Bendary F (2019) Fuzzy logic based dynamic braking scheme for stabilization of inter-area. *Acta Electronica Malaysia (AEM)* 3(2):16-22. <http://doi.org/10.26480/aem.02.2019.16.22>
16. Ahmed M F, Mandor M, El-Hadidy M, Bendary F (2019) Inter-area power oscillations mitigation for electrical systems via novel fuzzy control based braking resistor. In: Presented at 25th international conference on electricity distribution (CIRED) conference, pp 1–5
17. Kamwa I. Comparison of three power system stabilizer (PSS) using Kundur's four-machine two-area test system. MATLAB™ Demo. <https://www.mathworks.com/help/phymod/sps/examples/performance-of-three-pss-for-inter-area-oscillations.html>
18. Rómulo A (2017) Type-2 fuzzy logic uncertain systems' modelling and control. Springer-Verlag, Singapore. <https://www.springer.com/gp/book/9789811046322>
19. Castillo O, Melin P (2008) Type-2 fuzzy logic: theory and applications. Springer, Berlin
20. Panda MK, Pillai GN, Kumar V (2012) Power system stabilizer design: interval type-2 fuzzy logic controller approach. In: 2012 2nd International conference on power control and embedded systems (ICPCES). IEEE, pp 1-10. <https://doi.org/10.1109/ICPCES.2012.6508097>
21. Kamel S, Ziyad B, Naguib H M, Mouloud A, Mohamed R (2015) An indirect adaptive type-2 fuzzy sliding mode PSS design to damp power system oscillations. In: 7th international conference on modelling, identification and control (ICMIC 2015), IEEE, pp 1-6. <https://doi.org/10.1109/ICMIC.2015.7409472>
22. Saoudi K, Bouchama Z, Ayad M, Benziane M, Harmas M N (2016) Design of a robust PSS using an indirect adaptive type-2 fuzzy sliding mode for a multi-machine power system. In: 8th International conference on modelling, identification and control (ICMIC 2016), IEEE, pp 713-718. <https://doi.org/10.1109/ICMIC.2016.7804204>
23. Sharma A., Nagar L K, Patidar N P, Kolhe M L, Nandanwar S R, Puranik V N, Singh V K (2017) Minimizing uncertainties with improved power system stability using wide area fuzzy-2 logic based damping controller. In: 3rd IEEE international conference on computational intelligence and communication technology (IEEE-CICT), IEEE, pp 1-5. <https://doi.org/10.1109/CICT.2017.7977284>
24. Sharma MK, Vijay A, Pillai GN (2017) Stable type-2 fuzzy logic control of TCSC to improve damping of power systems. In: 2017 International conference on computer, communications and electronics, IEEE, pp 388–393. <https://doi.org/10.1109/COMPTELIX.2017.8004000>
25. Tripathy M, Mishra S (2011) Interval type-2-based thyristor-controlled series capacitor to improve power system stability. *IET Gener Transm Distrib* 5(2):209–222. <https://doi.org/10.1049/iet-gtd.2010.0035>
26. Raju SK, Pillai GN (2016) Design and implementation of type-2 fuzzy logic controller for DFIG-based wind energy systems in distribution networks. *IEEE Trans Sustain Energy* 7(1):345–353. <https://doi.org/10.1109/TSTE.2015.2496170>
27. Mendel J, Hagrass H, Tan WW, Melek WW, Ying H (2013) Introduction to type-2 fuzzy logic control: theory and applications. Wiley, New York
28. Taskin A, Kumbasar T (2015) An open source Matlab/Simulink toolbox for interval type-2 fuzzy logic systems. In: 2015 IEEE symposium series on computational intelligence, IEEE, pp 1561–1568. <https://doi.org/10.1109/SSCI.2015.220>

Publisher's Note

Springer Nature remains neutral with regard to jurisdictional claims in published maps and institutional affiliations.

Submit your manuscript to a SpringerOpen® journal and benefit from:

- Convenient online submission
- Rigorous peer review
- Open access: articles freely available online
- High visibility within the field
- Retaining the copyright to your article

Submit your next manuscript at ► [springeropen.com](https://www.springeropen.com)
